

SW01-W wind

SWS01-W wind-sun

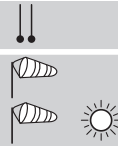

Model

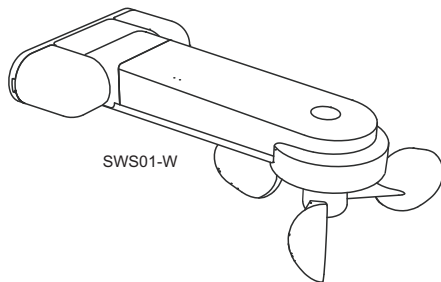

SW01-W01-01 wind
SWS01-W01-01 wind/sun

Technical Details

Coding:	EasywaveSens
Power supply:	230 V AC ~ 50 Hz
Connected load:	4 VA
Degree of protection:	IP44
Class of protection:	II
Operating temperature:	-25 °C bis +55 °C
Measuring ranges:	
- wind	3 km/h to 50 km/h
- light intensity	1 lx to 100 klx
Dimensions (BxLxH):	
- sensor	52/131x200x73 mm
- plate	121x52x30 mm
Weight:	260 g
Data line:	max. 25m

Scope of Delivery

- 1 Sensor SWSR01
- 1 Mounting plate
- 2 Cover caps
- 1 Terminal cover
- 1 Terminal block 2-pin
- 2 Hex bolts 6x40
- 2 Washers
- 2 Dowels SX8
- 1 Hexagon socket screw M6x65
- 1 Lock nut M6
- 2 Pan head screws
- Operating instructions

Intended use

The weather sensors are only for wire transmission of weather data to the Easywave radio receivers RCJ05, RCM04 or CM01 for weather-dependent control of awnings.

The manufacturer shall not be liable for any damage caused by improper or non-intended use!

Safety Advice



Before you connect and operate the device, please read these operating instructions carefully!

- The electrical installation must only be carried out by a qualified electrician (please refer to VDE 0100-200 and/or relevant national regulations).
- Repair, maintenance and cleaning work must only be carried out after the device has been disconnected from the mains power supply!
- Have faulty device checked by the manufacturer!
- Do not make any unauthorized alterations or modifications to the device!
- Keep the device out of the reach of children.



Function

The weather sensors continuously detect wind strength, light intensity and rain data and send this data via a wired connection to the control RCM04, RCJ05 or CM01. There, the data is evaluated and the awning is controlled accordingly.

Installation

When selecting a location for the device, please ensure that the light sensor and surface of the rain sensor are not covered or placed in the shade. Slipstreams should also be avoided.



We recommend assembling the weather sensor at a height of above 2.50 m. The installation height may by no means fall below 1.70 m.

For each installation, please ensure that the weather sensor is horizontal or is tilted downwards slightly at the front.

The impeller must always face downwards.

1. Screw the mounting plate to the installation site with the screws and dowels.
2. Insert the current and voltage-free mains cable and the Sensor cable through the terminal cover from below and clamp the wires to the terminal block provided.
3. Attach the terminal to the pin connector on the printed circuit board and securely fix the terminal cover (see also „Electrical connection“).
4. Place the sensor between the brackets of the Mounting plate and attach it with hexagon socket screw and the lock nut. Attach the cover caps.

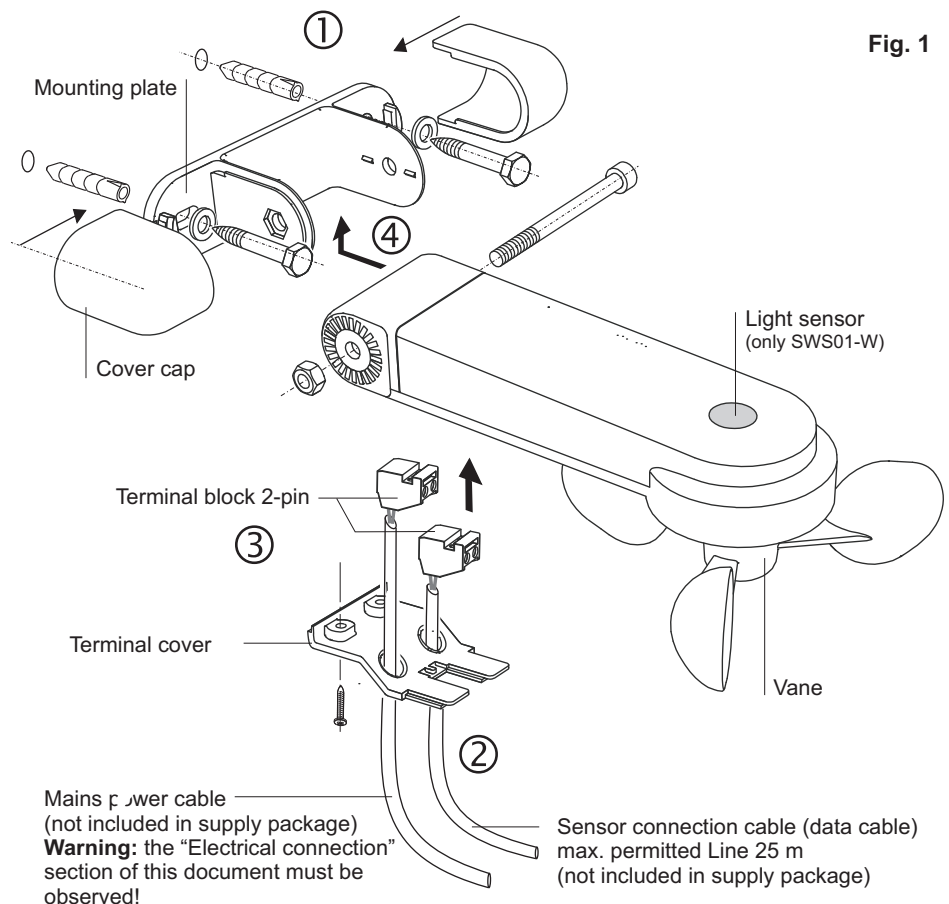

Fig. 1

Electrical connection



The operating voltage is 230 V. The electricity must be connected to the permanently fitted installation by an authorised electrically qualified person.

A safety and isolating device must be provided by the purchaser for activating the system.

A weatherproof and UV-resistant connection cable and data cable must be used.



The connection cables and the data cable cross section must completely seal off the lead-through opening in the connector cover.

Disconnect the power supply cable from the mains power supply before starting the installation work.

1. Place the terminal block with the attached cables onto the pins connector on the printed circuit board.

Mains connection: N L
Sensor connection: S- S+

2. Snap the terminal cover onto the lower section of the sensor housing and screw it tight with the pan head screws provided (see Fig. 1).

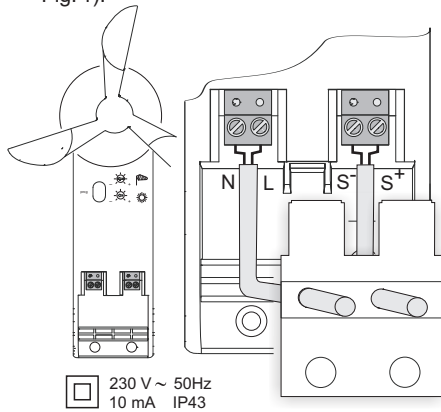

Set threshold value for wind

The sensor continuously measures wind speeds between 3 km/h und 50 km/h. Within this range, the wind value (threshold value) can be selected individually. The factory setting for this value is 11 km/h.

Turn the hand wheel of the potentiometer until the desired threshold value is obtained.

The currently measured value and the threshold value that has been set are transmitted to the radio receiver at 12-minute intervals. If there is a significant increase in the wind ($\geq 21\%$), the value measured is transmitted immediately.

The awning is then operated as prescribed by the control.

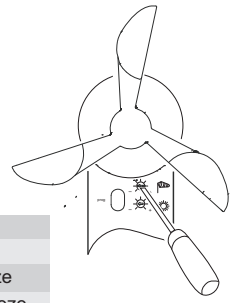
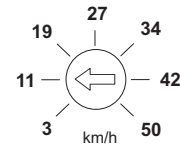

Wind speed km/h		
1	3	Light air
2	11	Light breeze
3	19	Gentle breeze
4	27	Moderate breeze
5	34	Fresh breeze
6	42	Strong breeze
7	50	High wind

Set threshold value for light intensity (only SWS01-W)

The sensor measures the light intensity periodically within the range of 1 lux to 100klux. Within this range, the light intensity value (threshold value) can be selected individually. The factory setting for this value is 10 klux.

The currently measured value and the threshold value that has been set are transmitted to the radio receiver at 3-minute intervals.

Turn the hand wheel of the potentiometer until the desired threshold value is obtained.

If the measured value is above or below the threshold value, then the awning is operated as prescribed by the control.

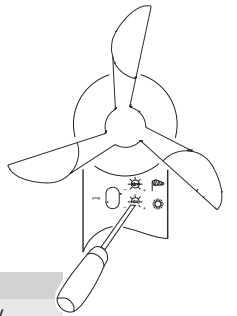
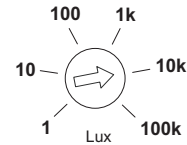

Light intensity in lux	
100k	Bright sunny day
20k	Dull sunny day
10k	In the shade in summer
3,5k	Dull winter day

Make / interrupt connection to radio receiver

To enable weather data to be transmitted to the control, the weather sensor transmission code must be programmed into the control as follows:

1. Activate the learning mode/delete mode in the control (refer to the instruction manual for the control).
2. Give the „prog“ transmit button on the sensor a short press; the LED will light up. The transmission code is transmitted to the control and the connection between the control and the sensor has been made or deleted.
3. Set the desired threshold value.



The setting for the threshold value depends upon the size and type of awning and on local conditions. Please take into account the wind resistance class for your awning!

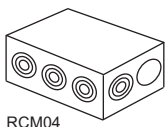

RCM04

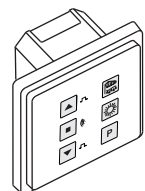

RCJ05

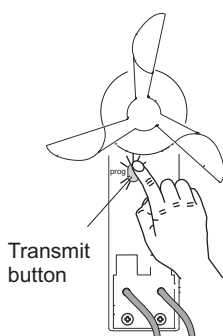

General Advice

Disposal

Waste electrical products not be disposed of with household waste!

Dispose of the waste product via a collection point for electronic scrap or via your specialist dealer.



Put the packaging material into the recycling bins for cardboard, paper and plastics.



Warranty

Within the statutory warranty period we undertake to rectify free of charge by repair or replacement any product defects arising from material or production faults.

Any unauthorized tampering with, or modifications to, the product shall render this warranty null and void.

Conformity

This product conforms to the basic requirements of the R&TTE Directive 1999/5/EC.

For use in: EU/CH/FL/IS/N

The Declaration of Conformity can be found on the Internet at: www.eldat.de



Service

If, despite correct handling, faults or malfunctions occur or if the product was damaged, please contact the company at the address below:

ELDAT GmbH

Im Gewerbepark 14,
15711 Koenigs Wusterhausen, Germany

Phone: + 49 33 75 / 90 37-310

Fax: + 49 33 75 / 90 37-90

Internet: www.eldat.de

E-Mail: info@eldat.de