

SW01	wind
SWS01	wind-sun
SWSR01	wind-sun-rain

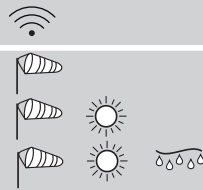

Model

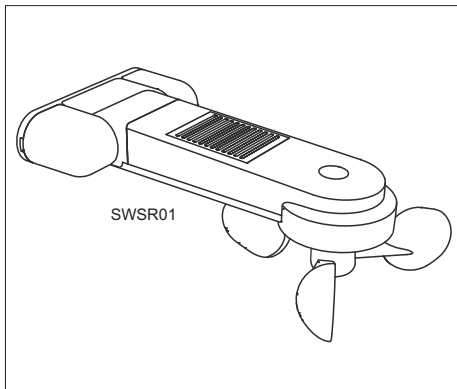

SW01E5001-01	wind
SWS01E5001-01	wind/sun
SWSR01E5001-01	wind/sun/rain

Technical Details

Frequency:	868,30 MHz
Modulation:	FSK
Coding:	EasywaveSens
Power supply:	230 V AC ~ 50 Hz
Connected load:	4 VA
Degree of protection:	IP43
Class of protection:	II
Range:	approx. 150 m under good free field conditions
Operating temperature:	-25 °C bis +55 °C
Measuring ranges:	
- wind	3 km/h to 50 km/h
- light intensity	1 lx to 100 klx
Dimensions (WxLxH):	
- sensor	52/131x200x73 mm
- plate	121x52x30 mm
Weight:	260 g

Scope of Delivery

- 1 Sensor
- 1 Mounting plate
- 2 Cover caps
- 1 Terminal cover
- 1 Terminal block 2-pin
- 2 Hex bolts 6x40
- 2 Washers
- 2 Dowels SX8
- 1 Hexagon socket screw M6x65
- 1 Lock nut M6
- 2 Pan head screws
- Operating instructions

Intended use

The radio weather sensors are only for radio transmission of weather data to the Easywave radio receivers RCJ05 or RCM04 for weather-dependent control of awnings.

The manufacturer shall not be liable for any damage caused by improper or non-intended use!

Safety Advice



Before you connect and operate the device, please read these operating instructions carefully!

The electrical installation must only be carried out by a qualified electrician (please refer to VDE 0100-200 and/or relevant national regulations).

Repair, maintenance and cleaning work must only be carried out after the device has been disconnected from the mains power supply!

Have faulty device checked by the manufacturer!

Do not make any unauthorized alterations or modifications to the device!

Keep the device out of the reach of children.



Function

The weather sensors continuously detect wind strength, light intensity and rain data and send this to the radio control RCJ05 or RCM04 by radio telegram. There, the data is evaluated and the awning is controlled accordingly.

The „gastronomy function“ integrated in the SWSR01 also allows the awning to be opened in rainy weather, contrary to the standard rain function.

Installation

When selecting a location for the device, please ensure that the light sensor and surface of the rain sensor are not covered or placed in the shade. Slipstreams should also be avoided.



We recommend assembling the weather sensor at a height of above 2.50 m. The installation height may by no means fall below 1.70 m.

For each installation, please ensure that the weather sensor is horizontal or is tilted downwards slightly at the front.

The impeller must always face downwards

1. Screw the mounting plate to the installation site with the screws and dowels. Make sure there is no interference with the radio connection. Do not mount the device in direct proximity to large metal objects.
2. Insert the current and voltage-free mains cable through the terminal cover from below and clamp the wires to the terminal block provided.
3. Attach the terminal to the pin connector on the printed circuit board and securely fix the terminal cover (see also „Electrical connection“).
4. Place the sensor between the brackets of the Mounting plate and attach it with hexagon socket screw and the lock nut. Attach the cover caps.

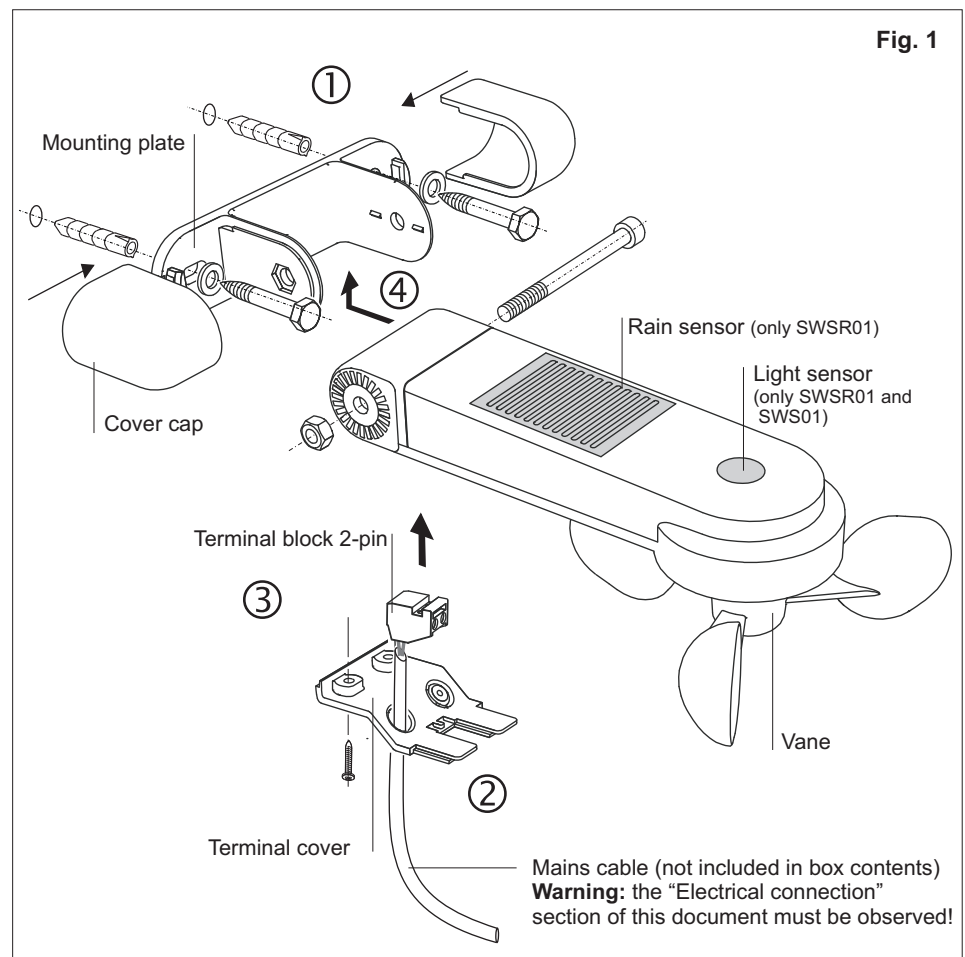

Electrical connection



The operating voltage is 230 V. The electrical connection must be carried out by a qualified and authorised electrician.

A safety and isolating device must be provided by the purchaser for activating the system.

A weatherproof and UV-resistant connection cable must be used.



The connection cable's cross section must completely seal off the lead-through opening in the connector cover.

Disconnect the power supply cable from the mains power supply before starting the installation work.

1. Place the terminal block with the attached cable onto the pin connector on the printed circuit board.
2. Snap the terminal cover onto the lower section of the sensor housing and screw it tight with the pan head screws provided (see Fig. 1).

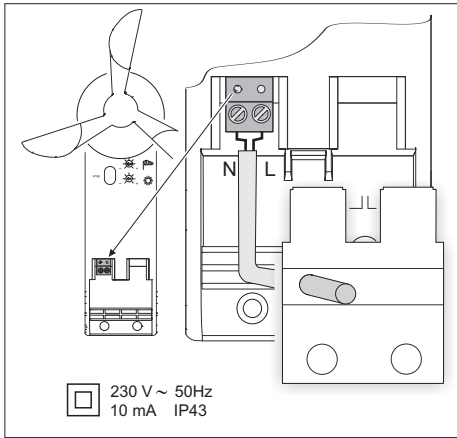

Set threshold value for wind

The sensor continuously measures wind speeds between 3 km/h und 50 km/h. Within this range, the wind value (threshold value) can be selected individually. The factory setting for this value is 11 km/h.

Turn the hand wheel of the potentiometer until the desired threshold value is obtained.

The currently measured value and the threshold value that has been set are transmitted to the radio receiver at 12-minute intervals. If there is a significant increase in the wind (21 %), the value measured is transmitted immediately.

The awning is then operated as prescribed by the control.

Set threshold value for light intensity (only SWSR01 and SWS01)

The sensor measures the light intensity periodically within the range of 1 lux to 100klux. Within this range, the light intensity value (threshold value) can be selected individually. The factory setting for this value is 10 klux.

Turn the hand wheel of the potentiometer until the desired threshold value is obtained.

The currently measured value and the threshold value that has been set are transmitted to the radio receiver at 3-minute intervals.

If the measured value is above or below the threshold value, then the awning is operated as prescribed by the control.

Rain detection (only SWSR01)

The rain sensor surface is continuously monitored. The status is transmitted to the control every 12 minutes. If the status changes from wet to dry or vice versa, this information is immediately transmitted to the radio receiver.

The awning is then operated as prescribed by the control.

The indirekt heating of the rain sensor surface allows the surface to dry quickly.

Gastronomy function (only SWSR01)

The procedure for switching the „gastronomy function“ ON/OFF is as follows.

1. Press the „prog“ button until the LED flashes.
2. Press the „prog“ button to switch the gastronomy function ON or OFF.
3. Finally, press the „prog“ button again until the LED goes off.

General Advice

Disposal

Waste electrical products not be disposed of with household waste!

Dispose of the waste product via a collection point for electronic scrap or via your specialist dealer.



Put the packaging material into the recycling bins for cardboard, paper and plastics.



Warranty

Within the statutory warranty period we undertake to rectify free of charge by repair or replacement any product defects arising from material or production faults.

Any unauthorized tampering with, or modifications to, the product shall render this warranty null and void.

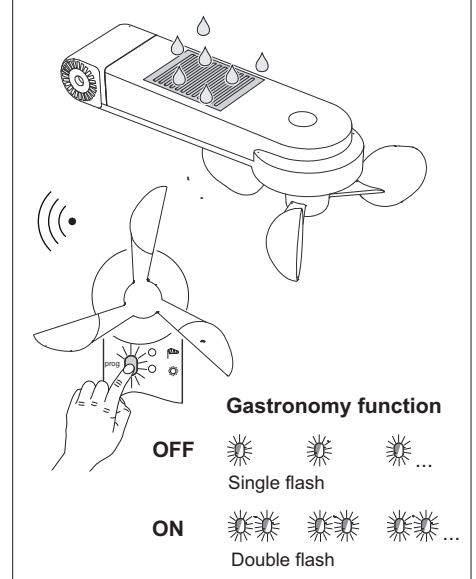
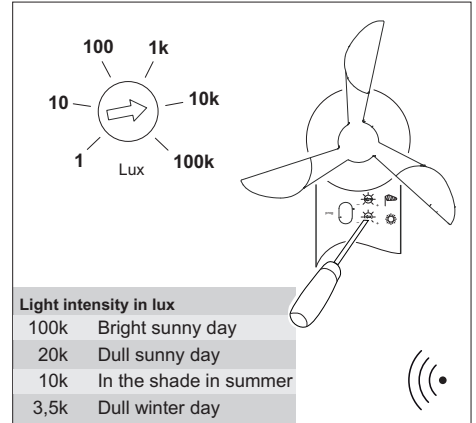
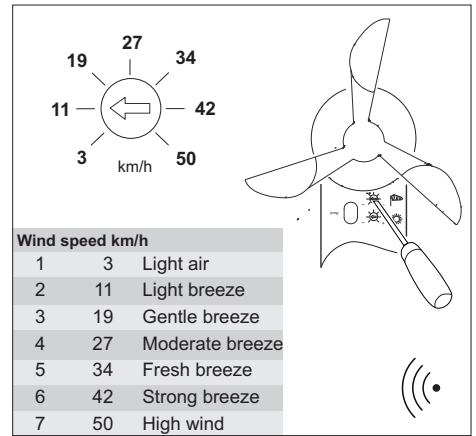

Make / interrupt connection to radio receiver

To enable weather data to be transmitted to the remote control, the weather sensor transmission code must be programmed into the control as follows:

1. Activate the learning mode/delete mode in the control (refer to the instruction manual for the control).
2. Give the „prog“ transmit button on the sensor a short press; the LED will light up. The transmission code is transmitted to the control and the connection between the control and the sensor has been made or deleted.
3. Set the desired threshold value.



The setting for the threshold value depends upon the size and type of awning and on local conditions. Please take into account the wind resistance class for your awning!

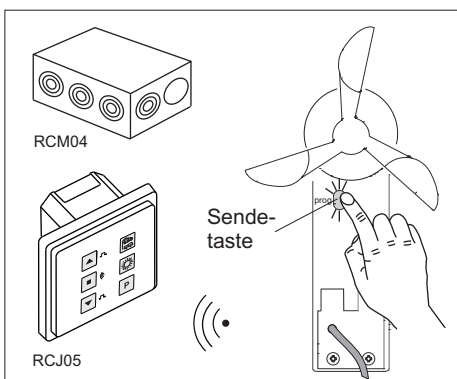

Conformity

This product conforms to the basic requirements of the R&TTE Directive 1999/5/EC.

For use in: EU/CH/FL/IS/N

The Declaration of Conformity can be found on the Internet at: www.eldat.de



Service

If, despite correct handling, faults or malfunctions occur or if the product was damaged, please contact the company at the address below:

ELDAT GmbH

Im Gewerbepark 14,
15711 Koenigs Wusterhausen, Germany

Phone: + 49 33 75 / 90 37-310

Fax: + 49 33 75 / 90 37-90

Internet: www.eldat.de E-Mail: info@eldat.de