

Model

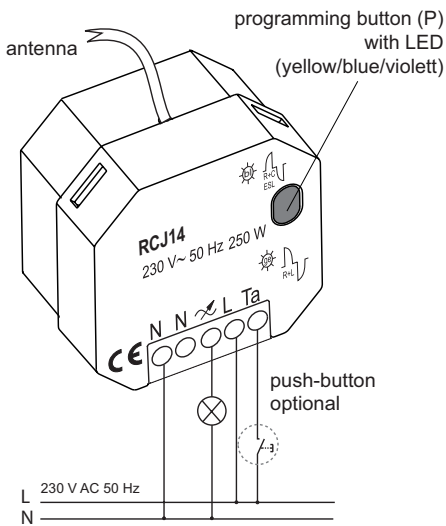

RCJ14E5001-01

Technical Details

Frequency:	868.30 MHz
Modulation:	FSK
Coding:	Easywave
Voltage supply:	230 V AC 50 Hz
Power consumption:	0.7 W stand by
Connected load:	
resistive load	7 W to 250 W
inductive load	20 VA to 250 VA
LED+ESL	7 W to 100 W
Operating temperature: for dry rooms only,	
	-20 °C to +60 °C
Protective class:	IP20
Dimensions (w/l/h):	48/48/25 mm

Scope of Delivery

Junction Box Dimmer RCJ14, operating manual

Intended Use

This device may only be used as a dimmer for switching and dimming lights of up to max. 250 W. It is operated using Easywave wireless transmitters or external controllers.

The manufacturer will not be liable for damage caused by improper or inappropriate use.

Safety Advice



Please read this instruction manual carefully before commissioning the device!

Warning! The electrical installation may only be performed by an authorised and qualified electrician. If it is not, there is a risk of electric shock or fire.

This device must not be used to switch or regulate electric motors.

This device must not be connected to the mains via an isolation transformer.

When using TRONIC transformers, the load specifications on the transformer must be observed.

Observe the valid laws, standards and regulations as well as the manufacturer's instructions regarding the devices to be controlled!

Have malfunctioning devices checked by the manufacturer!

Do not modify the device!

Function

The RCJ14 enables consumers of electricity to be wirelessly dimmed or switched.

An Easywave transmitter paired with the dimmer (one-button or two-button operation) enables soft switching of illuminants.

It is possible to pair up to a total of 32 transmitters.

The dimmer can also be programmed while fitted. This is only possible with a transmitter with a pairing button. When the PTx pairing button is pressed, a special Easywave signal is sent to the dimmer, which activates the pairing mode there.

An external controller can be connected to operate the dimmer locally.

An electronic short-circuit and overload safety device and an overheat safety device provide optimum safety.

There are three modes available to select from for the use of the dimmer:

- Dimming with memory function, i.e. the most recently selected brightness is stored, and then next time it is switched on, the lamp is lit at the same brightness again.
- Dimming without memory function involves simple brightening and dimming without any storage of brightness values.
- The setting of fixed brightness values is suitable for the creation of personalised lighting profiles.

The following settings have been programmed in as factory settings:

- Dimming mode: Leading edge,
- External button in mode „Dimming without memory function“ with single-button operation,
- Memory value: max. brightness.

Start-up

A Install the Dimmer.....	1
A1 Selecting a location.....	1
A2 Electrical connection.....	1
A3 Setting dimming mode.....	1
B Using the Dimmer.....	2
B1 Operating modes.....	2
C Programming.....	3
C1 Memorizing transmitter w/o learning button.....	3
C2 Deleting transmitter w/o learning button.....	3
C3 Reset.....	3
C4 Memorizing transmitter with learning button.....	4
C5 Deleting transmitter with learning button.....	4
D Troubleshooting.....	4
E Allgemeine Hinweise.....	4

A Install the Dimmer

A1 Selecting a location

Depending on the connected load, the dimmer will heat up during operation. If it is not possible to effectively conduct the heat away, the max. connected load must be reduced as follows:

15 % when installed in hollow walls, drywall or wooden walls,

25 % when installing multiple dimmers in rows or stacks.

Ensure an interference-free wireless connection. Avoid mounting at the following locations: in the immediate vicinity of large metal objects on the ground (or near it), because this will affect the range.

A2 Electrical connection

The dimmer must be fitted by a qualified electrician in a standard behind-the-wall socket (min. diameter 68 mm) in line with the wiring diagram and then switched on.

1. Shut off the power supply.
2. Connect the cable for the power supply and for the consuming devices as per the wiring diagram.
3. Activate the power supply and adjust the dimming mode in line with the connected consuming device (see A3, „Setting dimming mode“).
4. Pair the Easywave transmitted.
5. Close the installation socket using the cover.

When connecting halogen transformers or Tronic transformers in parallel, only devices of identical type may be used and the maximum load must not be exceeded.



It is not permitted to connect the following loads:

- Transformer halogen lamps and Tronic halogen lamps,
- Transformer halogen lamps and ESL/LED lamps.

In these cases, a separate dimmer must be used for each load.

A3 Setting dimming mode

Depending on the type of consuming device to be connected, the dimming mode is set as follows:

1. Hold down the P button on the dimmer (for around 10 seconds) until the LED alternately flashes yellow and blue. Once the button is released, the current dimming mode will be displayed.
2. Press the P button again until the LED lights up in the colour of the desired dimming mode:



blue TRAILING edge



yellow LEADING edge



violet Dimmable energy-saving bulbs (ESL)

3. Finally, press and hold P button until the LED goes out. The dimming mode has been saved.

TRAILING edge



Resistive and capacitive loads

Incandescent bulbs, high-voltage halogen lamps, electronic ballast devices for low-voltage halogen lamps, dimmable LED lamps (also for mixed loads such as incandescent bulbs with Tronic halogen lamps and incandescent bulbs with ESL/LED lamps)



Dimmable energy-saving bulbs (ESL)

The brightness upon activation is set to around 50% of the dimming curve, a later reduction in brightness is also possible.

LEADING edge



Resistive and inductive loads

Incandescent bulbs, High-voltage halogen lamps, Dimmable LED lamps (observe manufacturer specifications!), Wound transformers for low-voltage halogen lamps (also for mixed loads such as incandescent bulbs with Tronic halogen lamps)



B Using the dimmer

B1 Operating modes

The operating mode can be selected using the dimmer by pressing the P programming button several times until the LED flashes in the rhythm of the desired mode (see item C, „Programming“). Once a sender is paired, the selected mode is allocated to the transmitter buttons.

Each transmitter button sends an Easywave code A, B, C or D.

With two-button operation, the buttons A and C brighten or activate, while transmitter buttons B and D dim or switch off. Only one button needs to be paired; the code for the second button will be allocated automatically.

With one-button operation, each button can be used for dimming or brightening and for switching on and off.

Finally, the dimmer must be made ready for operation. To do this, the P programming button must be pressed several times until the LED on the dimmer ceases to blink.

Two-button dimming with memory

The most recently stored brightness is stored when switching off. Dimming or switching using two-button operation.

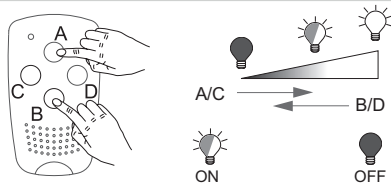

Brighten: Hold down transmitter button A or C until the desired brightness is reached.

Dim: Hold down transmitter button B or D until the desired brightness is reached

Switching ON to the stored brightness: Press and release transmitter button A or C quickly. If the lighting was switched off by means of dimming, it will be switched on to a discreet brightness (does not apply to energy-saving lamps).

Switching OFF: Press and release transmitter button B or D quickly.

Two-button dimming w/o memory

Brightening or dimming w/o stored the last brightness. Dimming or switching using two-button operation.

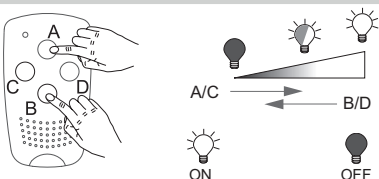

Brighten: Hold down transmitter button A or C until the desired brightness is reached.

Dim: Hold down transmitter button B or D until the desired brightness is reached.

Switching ON: Press and release transmitter button A or C quickly. The lighting will be switched to full brightness.

Switching OFF: Press and release transmitter button B or D quickly.

Two-button switching between fixed brightness values

Activation of personalised lighting profiles using two-button operation. The desired brightness can be set specifically using a transmitter.

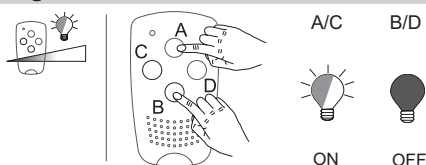

Dimming is not possible.

Switching ON: Press and release transmitter button A or C quickly. The lighting will be switched to the stored brightness.

Switching OFF: Press and release transmitter button B or D.

One-button dimming with memory

The most recently stored brightness is stored when switching off. Dimming or switching using one-button operation.

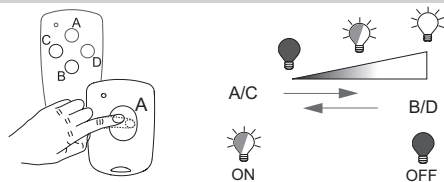

Brightening or dimming: Hold down the transmitter button. When the brightness limit has been reached, briefly release the button and then hold again to dim.

Switching ON or OFF to the stored brightness: Press and release the transmitter button quickly.

One-button dimming w/o memory

Brightening or dimming w/o stored the last brightness. Dimming or switching using one-button operation.

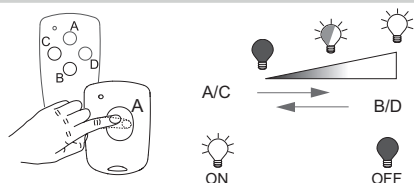

Brightening or dimming: Hold down the transmitter button. When the brightness limit has been reached, briefly release the button and then hold again to dim.

Switching ON: Press and release transmitter button quickly. The lighting will be switched to full brightness.

Switching OFF: Press and release transmitter button quickly.

One-button switching between fixed brightness values

Activation of personalised lighting profiles using one-button operation. The desired brightness can be set specifically using a transmitter.

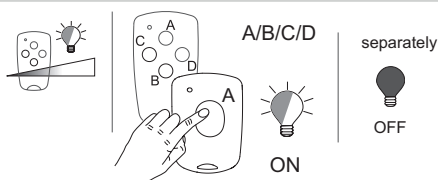

Dimming is not possible.

Switching ON to the stored brightness: Press and release the transmitter button quickly.

Switching OFF: The lighting will be switched through a separate transmitter or transmitter code.

One-button dimming by means of external button

An external button enables the dimmer to be operated by means of the one-button operation.

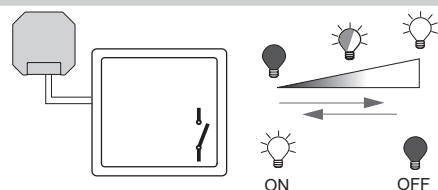

Brightening or dimming: Hold down the button. When the brightness limit has been reached, briefly release the button and then hold again to dim.

Switching ON: Press and release the button quickly. The lighting will be switched to full brightness.

Switching OFF: Press and release the button quickly.

C Programming

C1 Memorizing transmitter w/o learning button

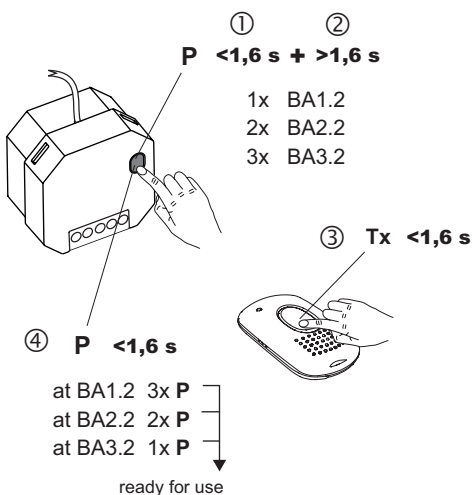
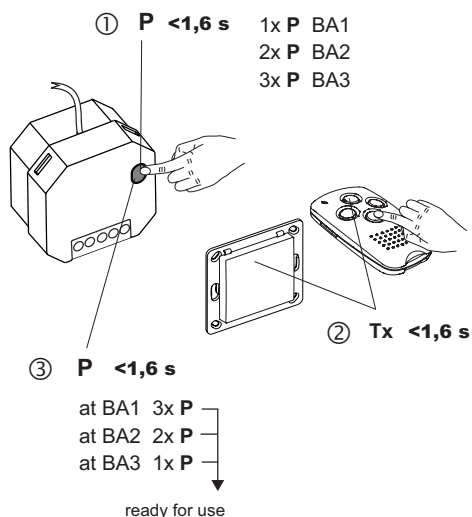

P programming button dimmer

Tx transmitter button

short Press the button for less than 1.6 s

long Press the button for longer than 1.6 s

Attention! Press the button not longer than 10 s. Otherwise, the unit switches in the „Setting dimming mode“.

C2 Deleting transmitters without learning button

This mode enables individual transmitters to be specifically cleared from the dimmer memory.

C3 RESET

A RESET can only be performed directly on the dimmer, not via the wireless interface.

All paired transmitters are deleted and the factory settings are restored:

- Dimming mode: Leading edge,
- External button in mode „Dimming without memory function“ with single-button operation,
- Memory value: max. brightness.

Press button ¹⁾	Display	Remark
Two-button dimming with memory (BA1)		
① P 1x short	LED flashes (1x break 1x ...)	dimmer in the learning mode BA1
② Tx 1x short	LED flashes ²⁾ after 4 s	transmitter memorized ³⁾
③ P 3x short	LED goes out	dimmer is ready for use
Two-button dimming w/o memory (BA2)		
① P 2x short	LED flashes (2x break 2x ...)	dimmer in the learning mode BA2
② Tx 1x short	LED flashes ²⁾ after 4 s	transmitter memorized ³⁾
③ P 2x short	LED goes out	dimmer is ready for use
Two-button switching between fixed brightness values (BA3)		
⚠ Dim the lights first in a different mode to the desired brightness and keep the light burning.		
① P 3x short	LED flashes (3x break 3x ...)	dimmer in the learning mode BA3
② Tx 1x short	LED flashes ²⁾ after 4 s	transmitter memorized ³⁾ and brightness stored
③ P 1x short	LED goes out	dimmer is ready for use

One-button dimming with memory (BA1.2)		
① P 1x short	LED flashes (1x break 1x ...)	dimmer in the learning mode BA1.2
② P 1x short	LED briefly lights red	
③ Tx 1x short	LED flashes ²⁾ after 4 s	transmitter memorized ³⁾
④ P 3x short	LED goes out	dimmer is ready for use
One-button dimming w/o memory (BA2.2)		
① P 2x short	LED flashes (2x break 2x ...)	dimmer in the learning mode BA2.2
② P 1x long	LED briefly lights red	
③ Tx 1x short	LED flashes ²⁾ after 4 s	transmitter memorized ³⁾
④ P 2x short	LED goes out	dimmer is ready for use
One-button switching between fixed brightness values (BA3.2)		
⚠ Dim the lights first in a different mode to the desired brightness and keep the light burning.		
① P 3x short	LED flashes (3x break 3x ...)	dimmer in the learning mode BA3.2
② P 1x long	LED briefly lights red	
③ Tx 1x short	LED flashes ²⁾ after 4 s	transmitter memorized ³⁾ and brightness stored
④ P 1x short	LED goes out	dimmer is ready for use

Press button ¹⁾	Display	Remark
1. P 1x lang	LED flashes quickly in the colour of the configured dimming mode	dimmer in the deleting mode
2. Tx 1x kurz	LED lights for 4 s	transmitter deleted
3. P 1x kurz		dimmer is ready for use

Press button ¹⁾	Display	Remark
1. P 1x lang	LED blinkt schnell in der Farbe der eingestellten Dimmart	dimmer in the deleting mode
2. P 1x lang	LED lights for 4 s	factory settings are restored

- 1) If no button is pressed within 20 seconds, the dimmer will automatically enter a state of operational readiness. The configuration is not stored.
- 2) If the LED lights red, an attempt is being made to pair an existing transmitter. Clear the paired transmitter.
- 3) If the operating mode programmed for the transmitter has to be changed, the transmission code must be deleted first and then re-memorized with the new operating mode.

C Programming

C4 Memorizing transmitter with learning button

If the settings of the dimmer also be changed in the installed state, a learning transmitter must be programmed before to installation (see chapter C1).

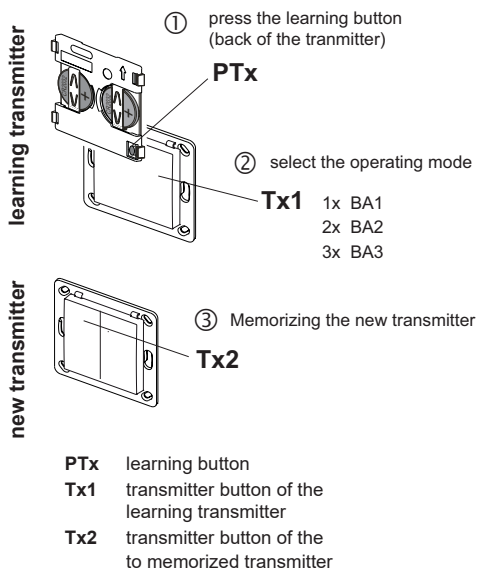

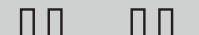
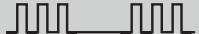
Press button ¹⁾	Display	Remark
Two-button dimming with memory (BA1)		
① PTx short	transmitter LED flashes red	
② within 5 s Tx1 1x short	lighting flashes according to operating mode	 dimmer in the learning mode BA1
③ Tx2 short	lighting lights for 4 s	transmitter memorized ²⁾ and dimmer is ready for use
Two-button dimming without memory (BA2)		
① PTx short	transmitter LED flashes red	
② within 5 s Tx1 2x short	lighting flashes according to operating mode	 dimmer in the learning modes BA2
③ Tx2 short	lighting lights for 4 s	transmitter memorized and dimmer is ready for use
Two-button switching between fixed brightness valuesn (BA3)		
① PTx short	transmitter LED flashes red	
② within 5 s Tx1 3x short	lighting flashes according to operating mode	 dimmer in the learning mode BA3
③ Tx2 short	lighting lights for 4 s	transmitter memorized ²⁾ and dimmer is ready for use

C5 Deleting transmitters with learning button

In order to ensure constant access to the dimmer, the last learning transmitter is always memorized. A learning transmitter used to delete can't be deleted.

Press button ¹⁾	Display	Remark
1. PTx short	transmitter LED flashes	
2. within 5 s Tx1 long (>5 s)	lighting flashes rapidly, full brightness	Attention! Release the transmitter button after 5 s! dimmer in the deleting mode
3. Tx2 short	lighting lights for 4 s	transmitter deleted and change in the operational readiness

- 1) If no button is pressed within 10 seconds, the dimmer will automatically enter a state of operational readiness. The configuration is not stored.
- 2) If the operating mode programmed for the transmitter has to be changed, the transmission code must be deleted first and then re-memorized with the new operating mode.

D Troubleshooting

Display	Problem	Solution
LED flashes RED slowly or Lighting can't be switched	An inductive load has been recognised in trailing edge mode.	Hold down the P button on the dimmer while the LED is flashes until the LED alternately flashes yellow and blue. Then select the correct dimming mode as per item A3.2.
LED flashes RED rapidly	The load current is too high.	The dimmer will automatically reduce the brightness step by step. Reduce illuminant output!
LED lights RED or Lighting can't be switched	Short circuit on the consuming device	Shut off the power supply, eliminate short circuit, reactivate power supply.
LED flashes RED rhythmically 	Temperature increase in housing	At 80°C, the device will automatically dim to 50% of the configured dimming value. From 85°C, the load will automatically be shut off. Manually shut off load / reduce illuminant output! The flashing will stop once the temperature has dropped to below 80°C again.

E General Information

Disposal

Waste electrical products should not be disposed of with household waste!

Dispose of the waste product via a collection point for electronic scrap or via your specialist dealer
Put the packaging material into the recycling bins for cardboard, paper and plastics.



Warranty

We will remedy defects on the device based on material or production errors within the statutory warranty period or exchange the device.
Any unauthorized tampering with, or modifications to, the product shall render this warranty null and void.

Conformity

Hereby, ELDAT Eas GmbH declares that the radio equipment type RCJ14 is in compliance with Directive 2014/53/EU. The full text of the EU declaration of conformity is available at the following internet address: www.eldat.de



Customer Service

If the device does not work properly despite proper handling or in case of damage, please contact the manufacturer or your retailer.

ELDAT Eas GmbH

Schmiedestraße 2
15745 Wildau
Germany

Phone: + 49 (0) 33 75 / 90 37-0
Fax: + 49 (0) 33 75 / 90 37-90
Internet: www.eldat.de
E-Mail: info@eldat.de